

Toronto

Typ A1

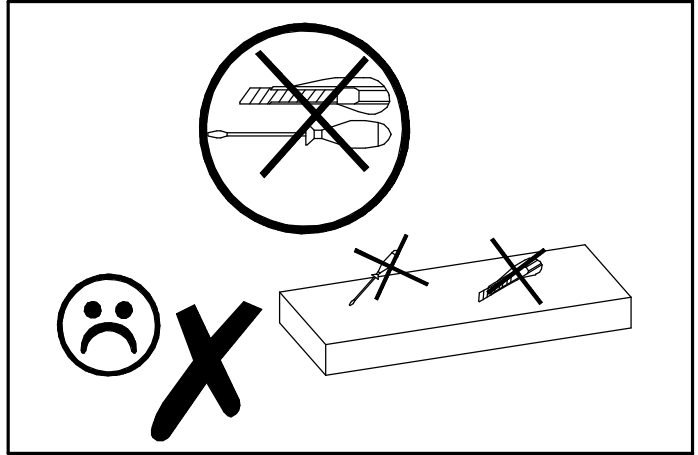

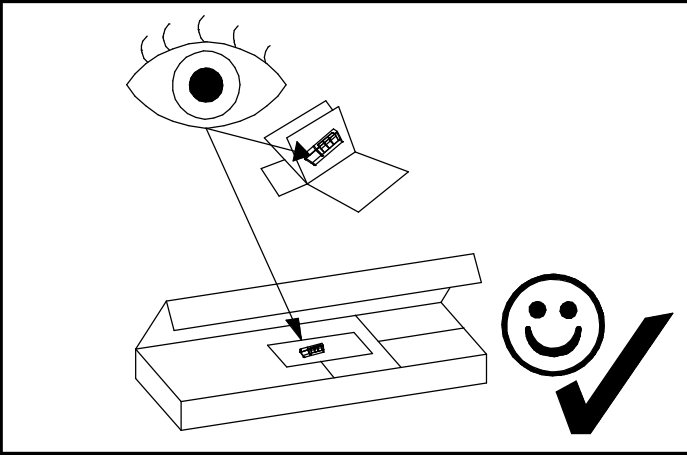

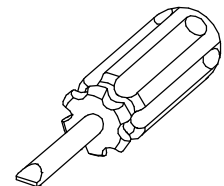
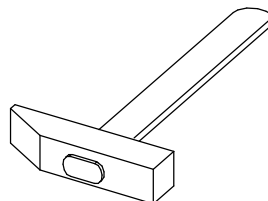
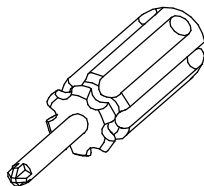
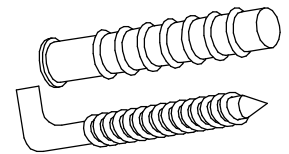
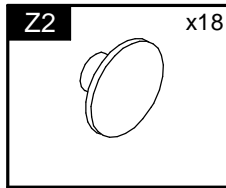
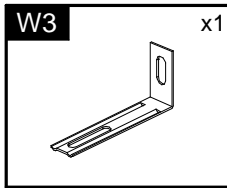
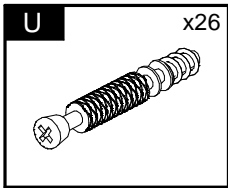
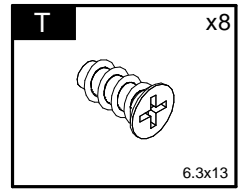
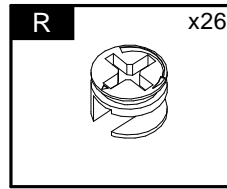
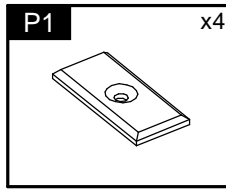
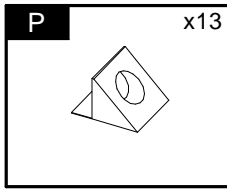
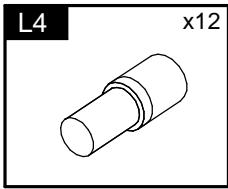
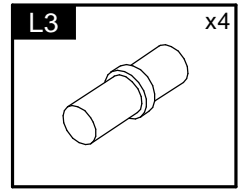
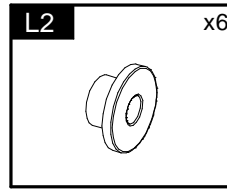
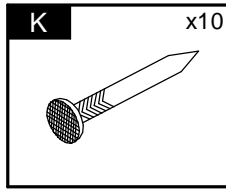
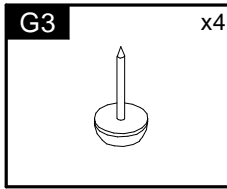
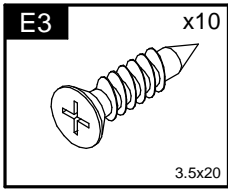
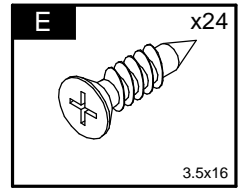
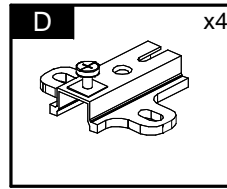
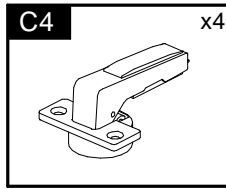
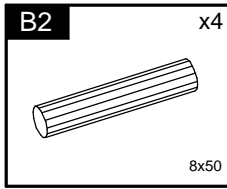
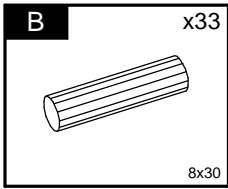
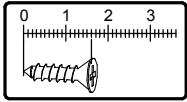

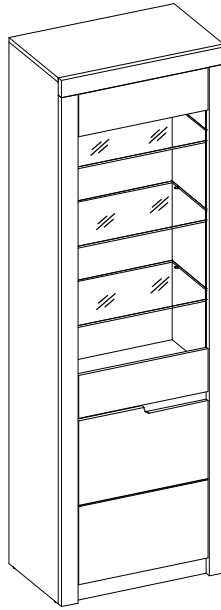

Element symbol	Measurements				Code	Paket
1	1956	375	16	1	1002	1/4
2	1956	375	16	1	1003	1/4
3	630	375	16	1	1004	1/4
4	597	355	16	1	1005	1/4
5	597	65	16	1	1007	1/4
6	597	70	16	1	1039	1/4
7	597	355	16	1	1038	1/4
8	596	345	16	1	N/A	1/4
9	597	65	16	1	1001	1/4
10	1246	611	3	1	N/A	1/4
11	650	611	3	1	N/A	1/4
12	617	497	16	1	3025	2/4
13	497	162	16	1	3043	2/4
14	497	162	16	1	3044	2/4
15	630	65	19	1	4001	1/4
16	1907.5	65	19	1	4002	1/4
17	1907.5	65	19	1	4003	1/4
18	955	495	4	1	Glass	3/4
19	595	340	6	3	Glass	4/4

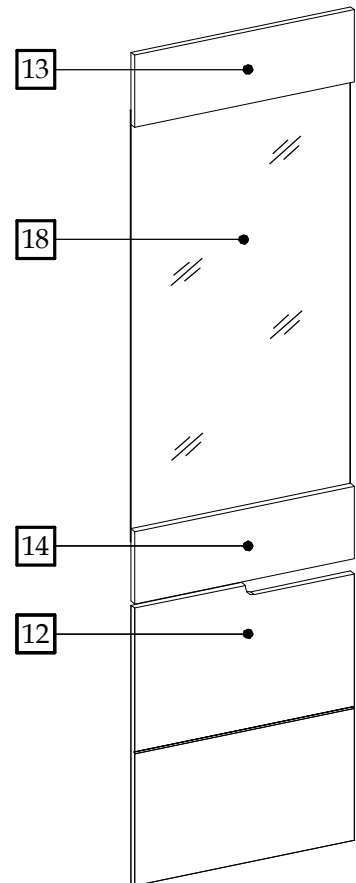
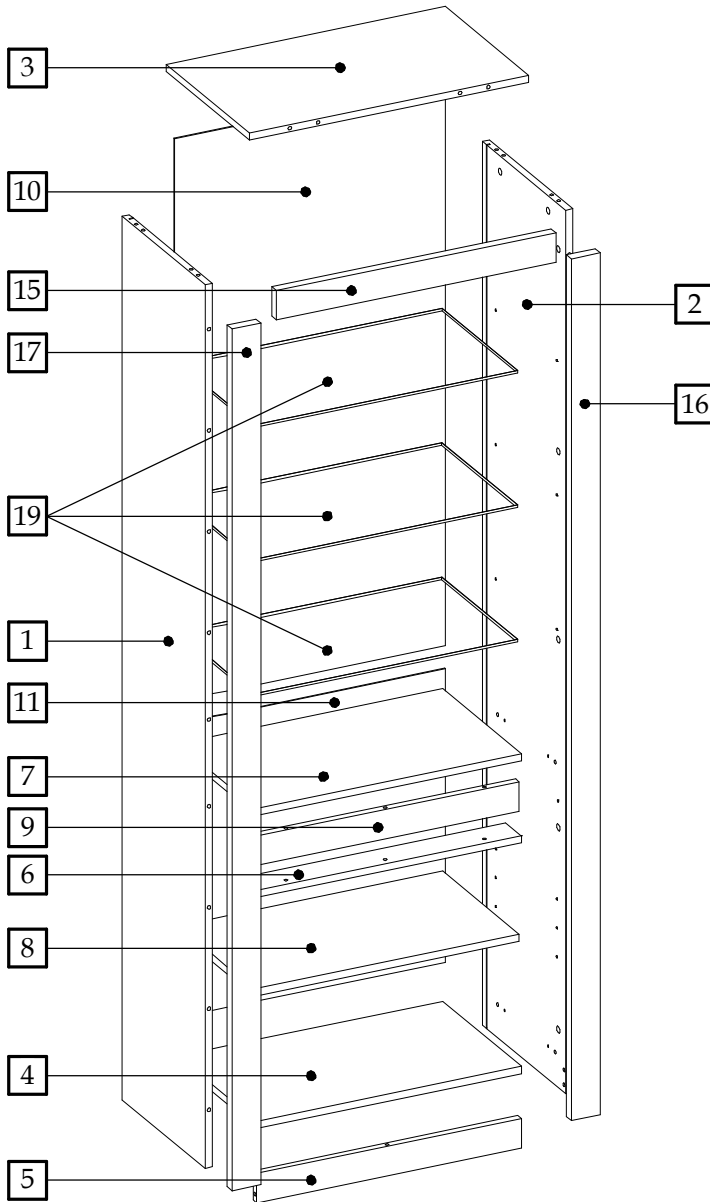

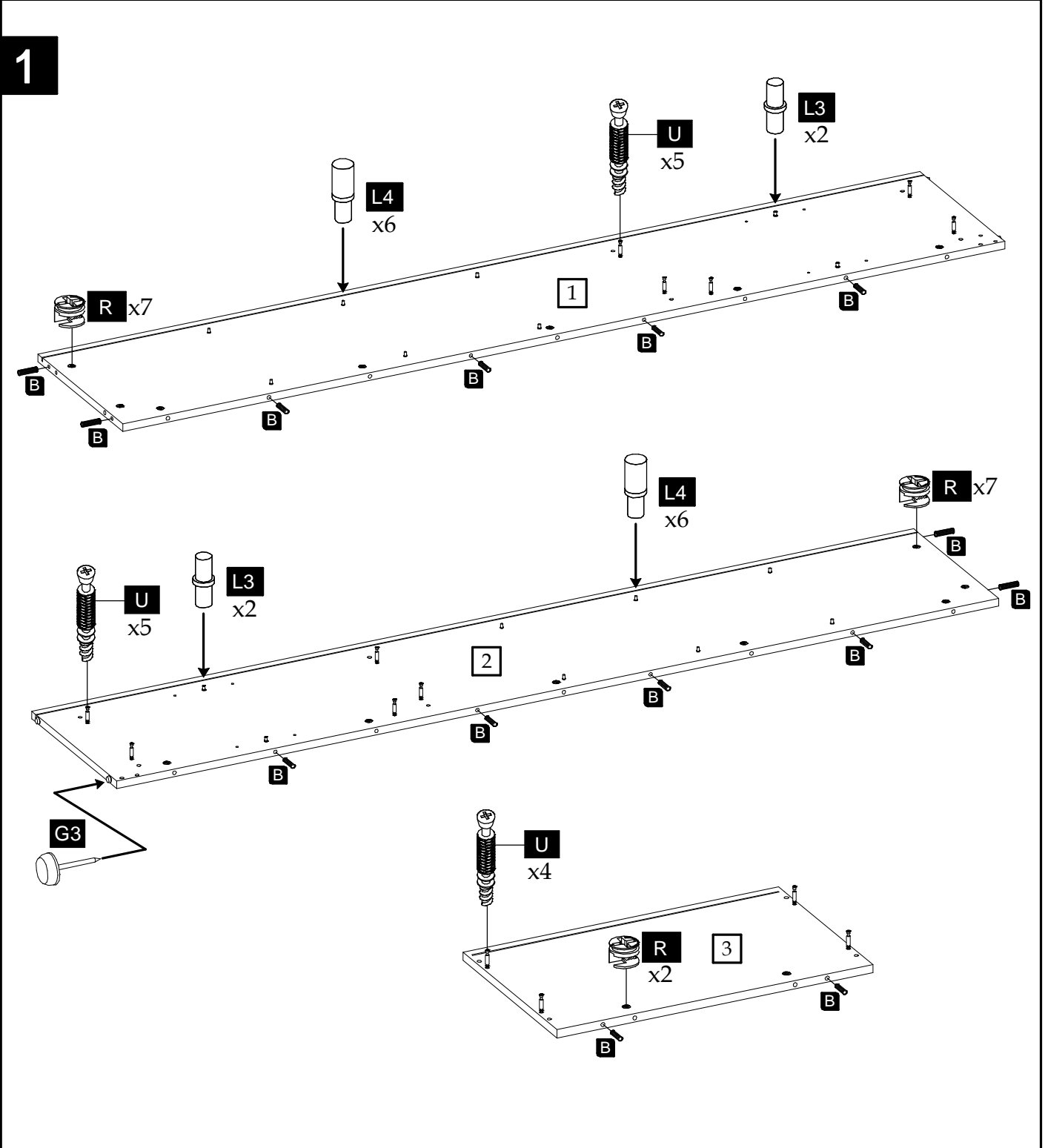

2

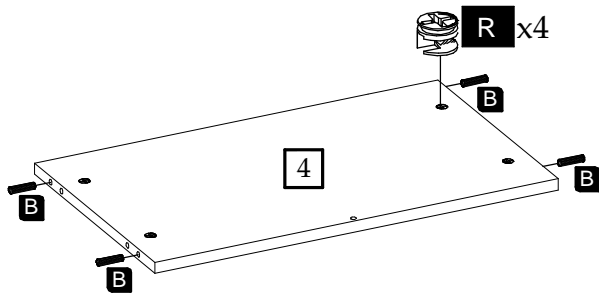
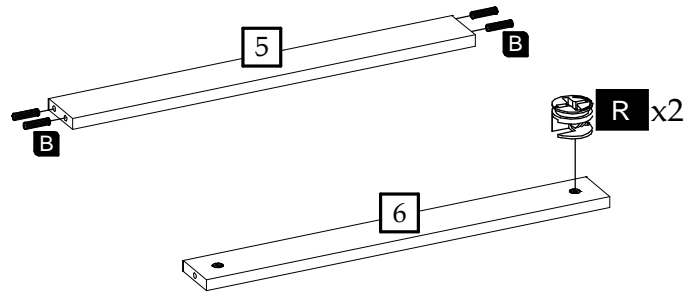
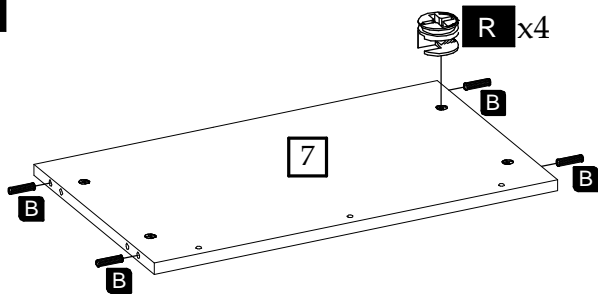

3

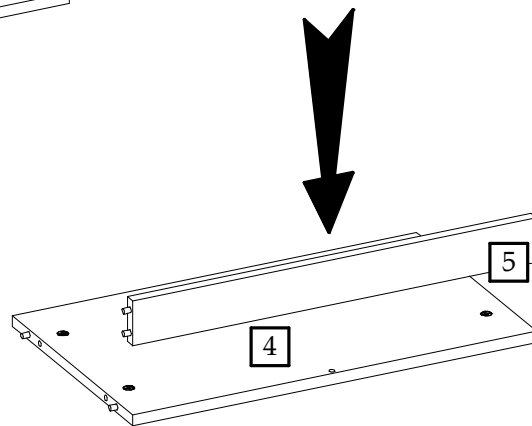
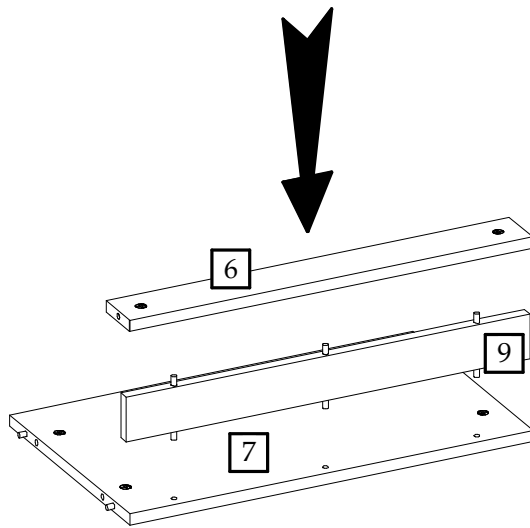

4

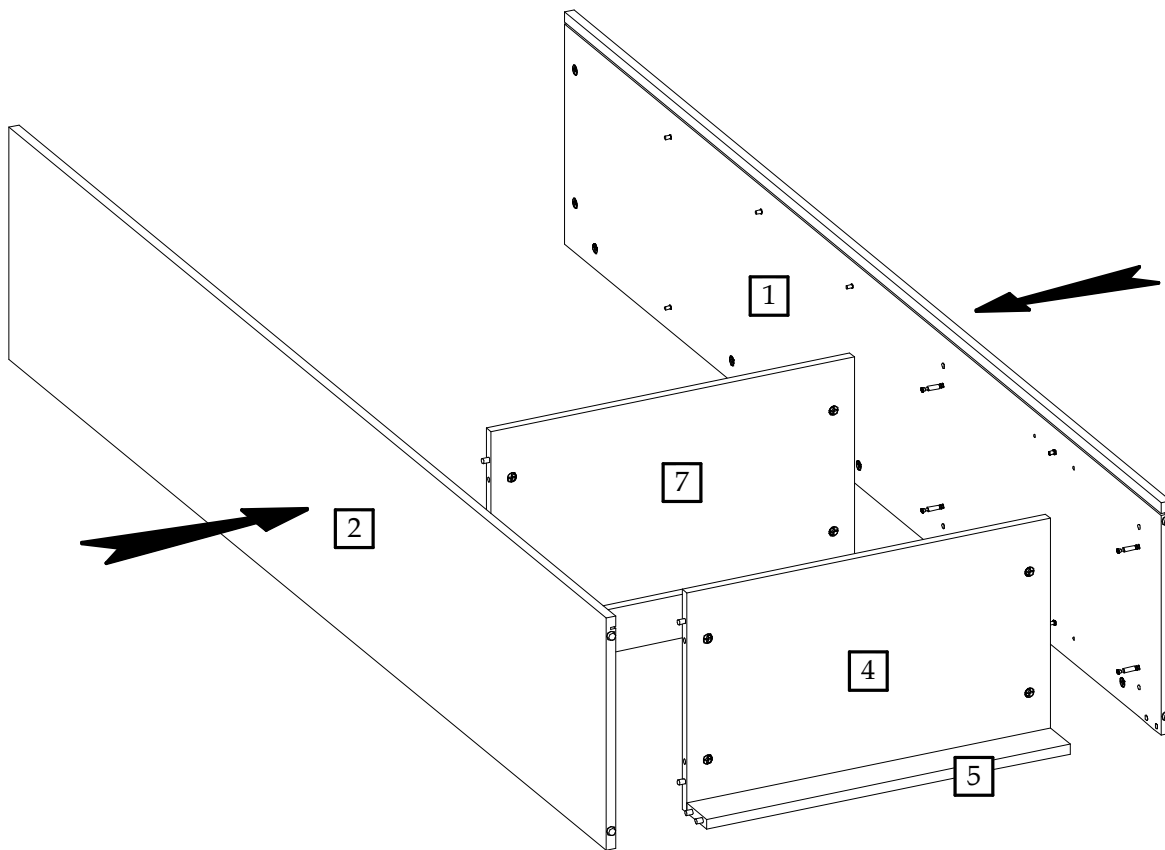

5

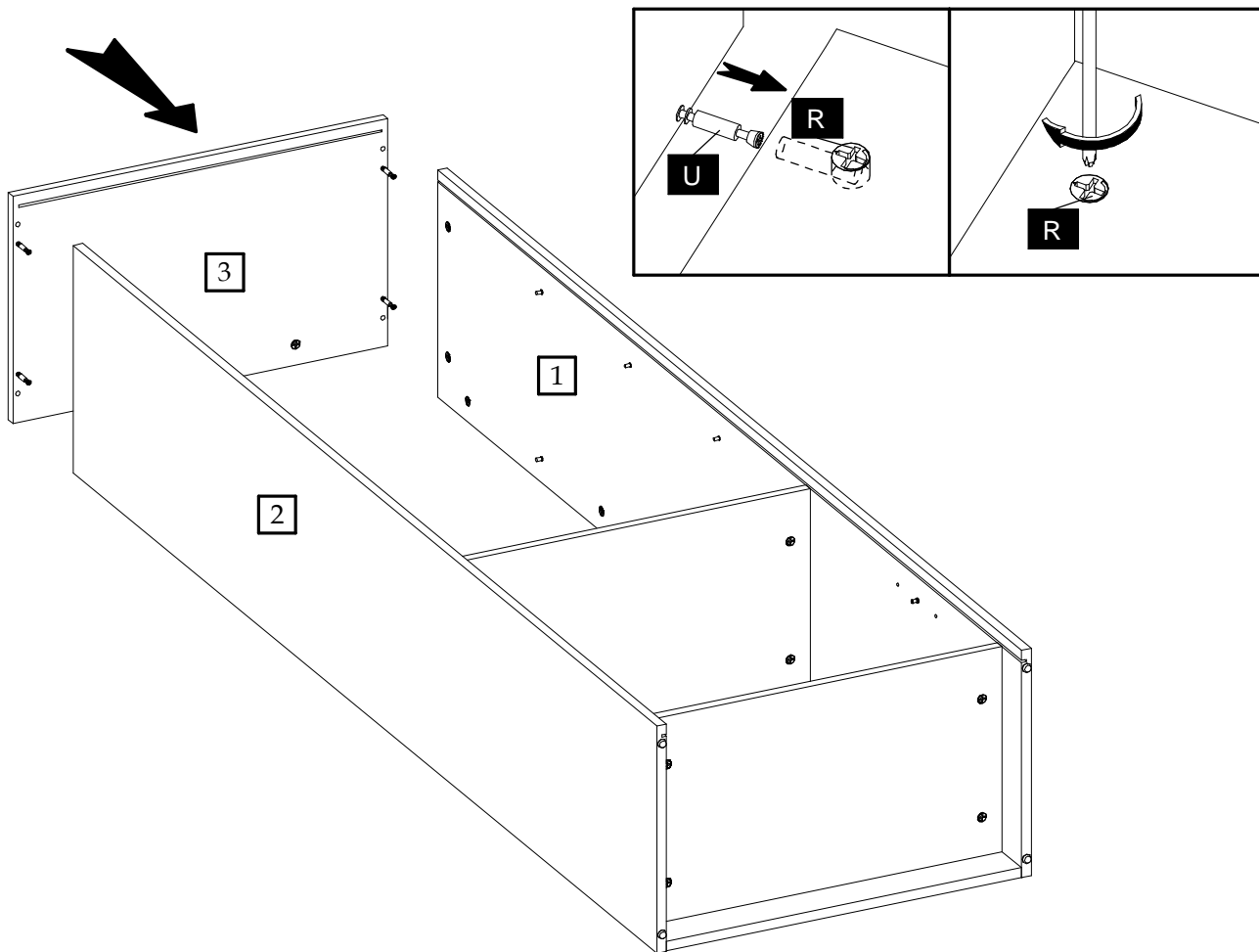

6

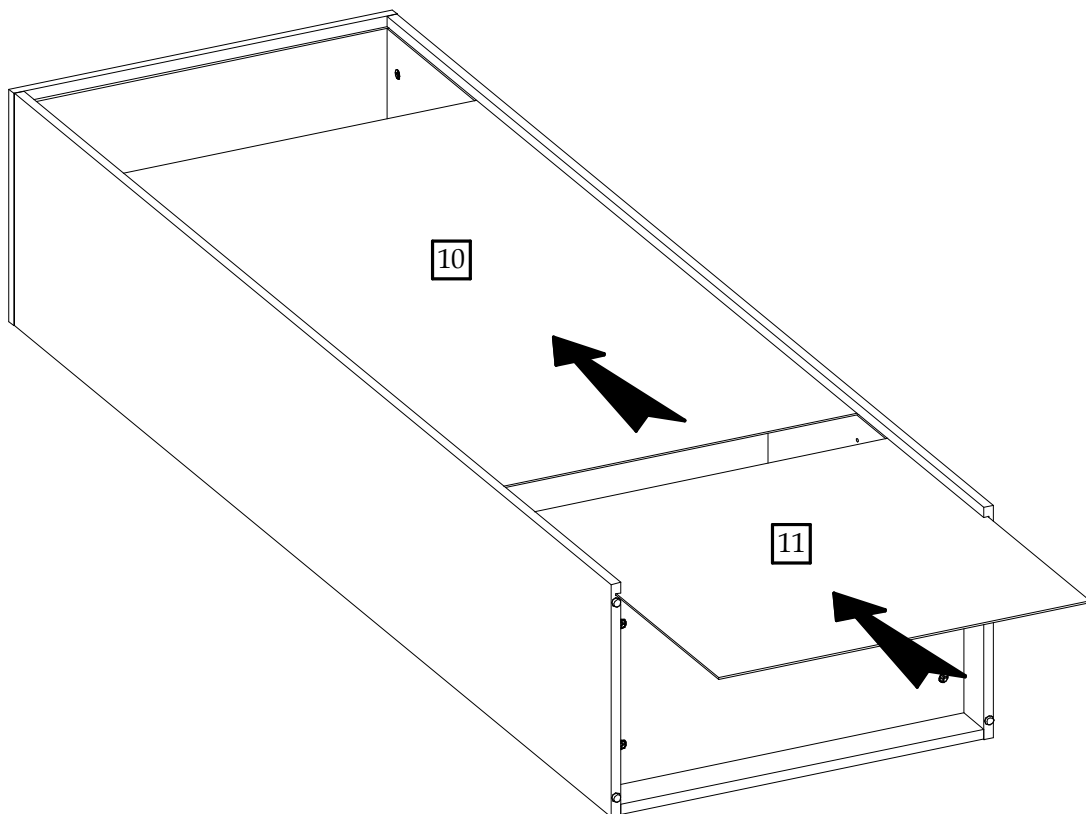

7

